



NIHON KOHDEN
CORPORATION

OPERATOR'S MANUAL

TEMPERATURE MODULE ✓

MODEL AW-601H

AW-650H

GENERAL HANDLING PRECAUTIONS

**This device is intended for use only
by qualified medical personnel.**

**Please read these precautions thoroughly
before attempting to operate the instrument.**

1. To safely and effectively use the instrument, its operation must be fully understood.
2. When installing or storing the instrument, take the following precautions:
 - (1) Avoid moisture or contact with water, extreme atmospheric pressure, excessive humidity and temperatures, poorly ventilated areas, and dusty, saline or sulphuric air.
 - (2) The instrument should be placed on an even, level floor. Vibration and mechanical shock should be avoided even during moving.
 - (3) Avoid placing in an area where chemicals are stored or where there is danger of gas leakage.
 - (4) The power line source to be applied to the instrument should correspond in frequency and voltage to specifications, and have allowable current capacity.
 - (5) Choose a room where a proper grounding facility is available.

3. Before operation:

- (1) Check that the instrument is in perfect operating order.
- (2) Check that the instrument is grounded properly.
- (3) Check that all cords are connected properly.
- (4) Pay extra attention when the instrument is in combination with other instruments to avoid mis-diagnosis or other problems.
- (5) All circuitry used for direct patient connection must be doubly checked.
- (6) Check that battery voltage and battery condition are perfect when using battery-operated models.

4. During operation:

- (1) Both the instrument and the patient must receive constant and careful attention.
- (2) Turn power off or remove electrodes and/or transducers when necessary to assure the patient's safety.
- (3) Avoid direct contact between the instrument and the patient.

5. To shutdown after use:

- (1) Turn power off with all controls returned to their original positions.
- (2) Remove the cords gently; do not use force to remove them.
- (3) Clean the instrument together with all accessories to keep them ready for their next use.

6. The instrument must receive expert, professional attention for maintenance and repairs. When the instrument is not functioning properly, it should be clearly marked to avoid operation while it is out of order.

7. The instrument must not be altered or modified in any way.

8. Maintenance and inspection:

- (1) The instrument and parts should undergo regular maintenance inspections.
- (2) If stored for extended periods without being used, make sure prior to operation that the instrument is in perfect operating condition.

9. When the instrument is used with an electrosurgical instrument, careful attention should be paid to the application and/or location of electrodes and/or transducers to avoid possible burn to the patient.

10. When the instrument is used with a defibrillator, make sure that the instrument is protected against defibrillator discharge. If not, remove patient cables and/or transducers from the instrument to avoid possible damage.

CONTENTS

	PAGE
INTRODUCTION	1
FEATURES	1
COMPOSITION	1
CONTROLS AND SWITCHES	4
MEASUREMENT (TEMPERATURE)	6
System Composition	
Connection Board Wiring	
Power on	
Thermistor Probe Placement	
Calibration	
Internal Switch Setting	
Measurement	
MEASUREMENT (TEMPERATURE DIFFERENCE)	10
System Composition	
Connection Board Wiring	
Thermistor Pickup	
Calibration	
Measurement	
STERILIZATION	11
ALPHANUMERIC ANNOTATION	11
SPECIFICATIONS	12
OPTIONAL ACCESSORIES	13
PANEL ILLUSTRATION	15

Introduction

The temperature module AW-601H is a plug-in unit of the RM-6000 series Polygraph System. A thermistor whose resistance varies greatly according to the temperature is used as a temperature sensing element.

Since the thermistor is quite small, it is suited for measuring the temperature of a small surface area. The small heat capacity of the thermistor permits measurement of rapid temperature change in the subject without delay. The thermistor probe, the coupler, and the module make the system highly sensitive and accurate in temperature reading for medical use. The temperature is displayed on a 3-digit LED readout with a decimal point.

Please read this manual thoroughly before operating the instrument. Also refer to the operator's manual of the Polygraph Amplifier Console and the other plug-in units.

Features

1. Displays the temperature of humans, animals, liquids etc. in digital figures.
2. The coupler system permits temperature measurement of a subject located far from the main unit of the temperature meter, since the coupler installed in a coupler housing can be separated from the temperature module and be placed near the subject.
3. Permits temperature difference measurement between two points.
4. A built-in suppression circuit enables it to magnify and record a small temperature change.
5. Automatic changeover between the probe's low and high temperature ranges.

Composition

The Temperature Module AW-601H, a plug-in unit of the RM-6000 series Polygraph, should be plugged into the Mini-Polygraph or the polygraph Amplifier Console (RMP-6004/6008/6018) when in use. The Temperature Coupler AW-650H can be plugged directly into the AW-601H or can be accommodated in the Coupler Housing (JH-620H, or JH-640H).

COMPOSITION EXAMPLES

* Standard temperature measurement

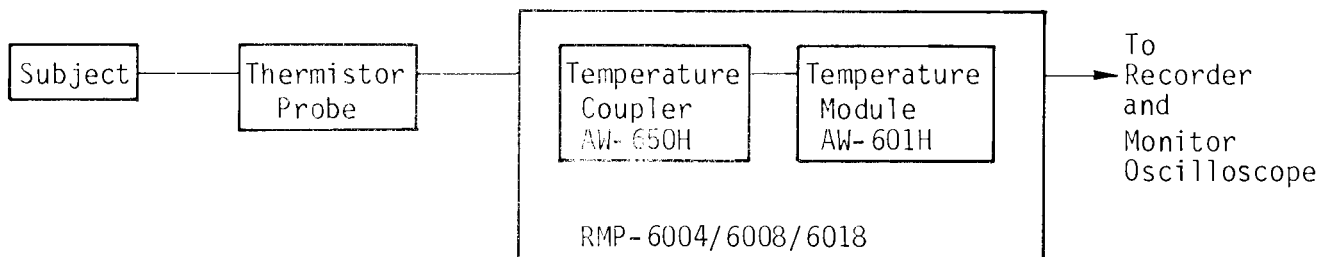

AW-601H/650H(A)

* Selective temperature measurement from up to four measuring sites.

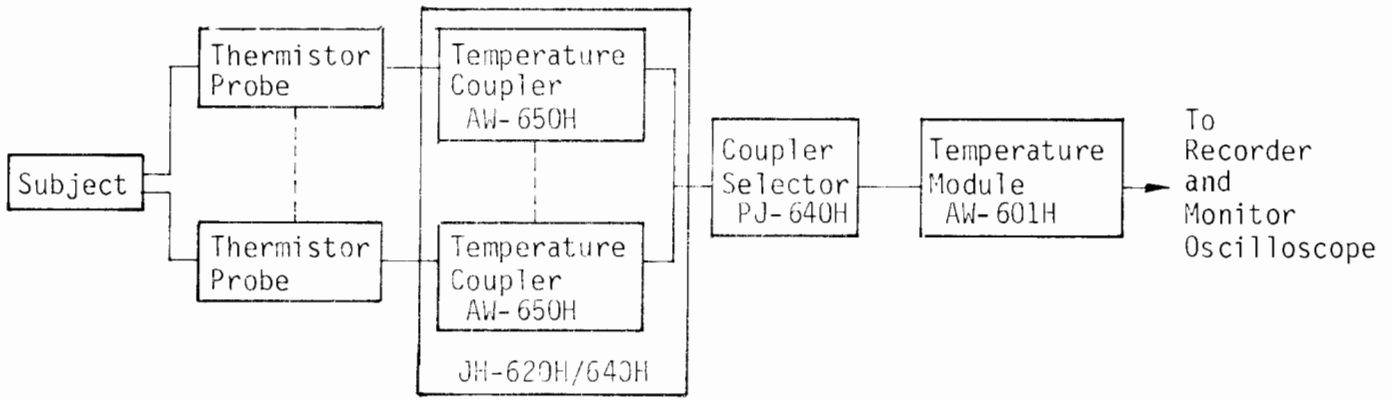

* Temperature difference measurement

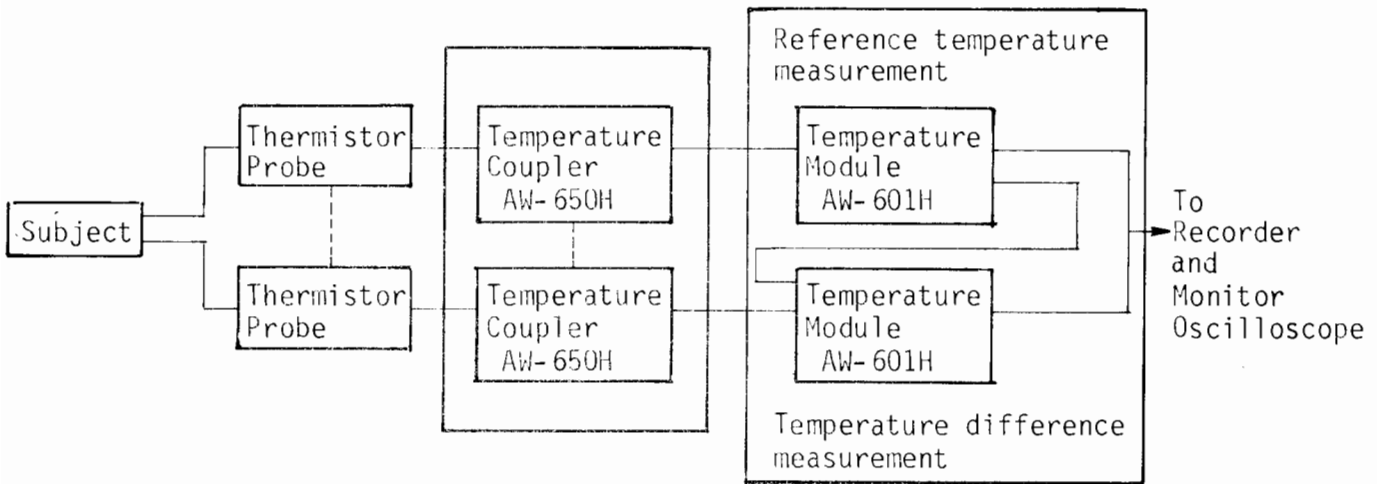

BLOCK DIAGRAMS

* AW-650H Block diagram

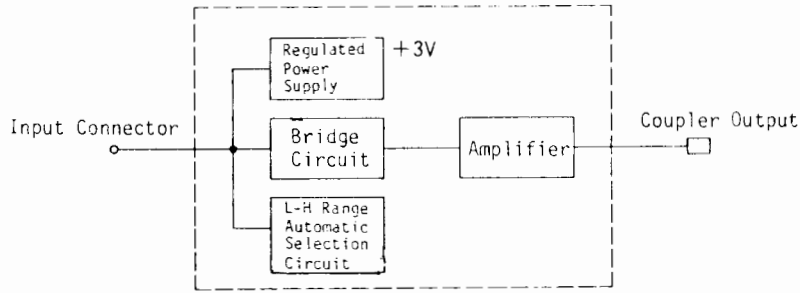

* AW-601H Block diagram

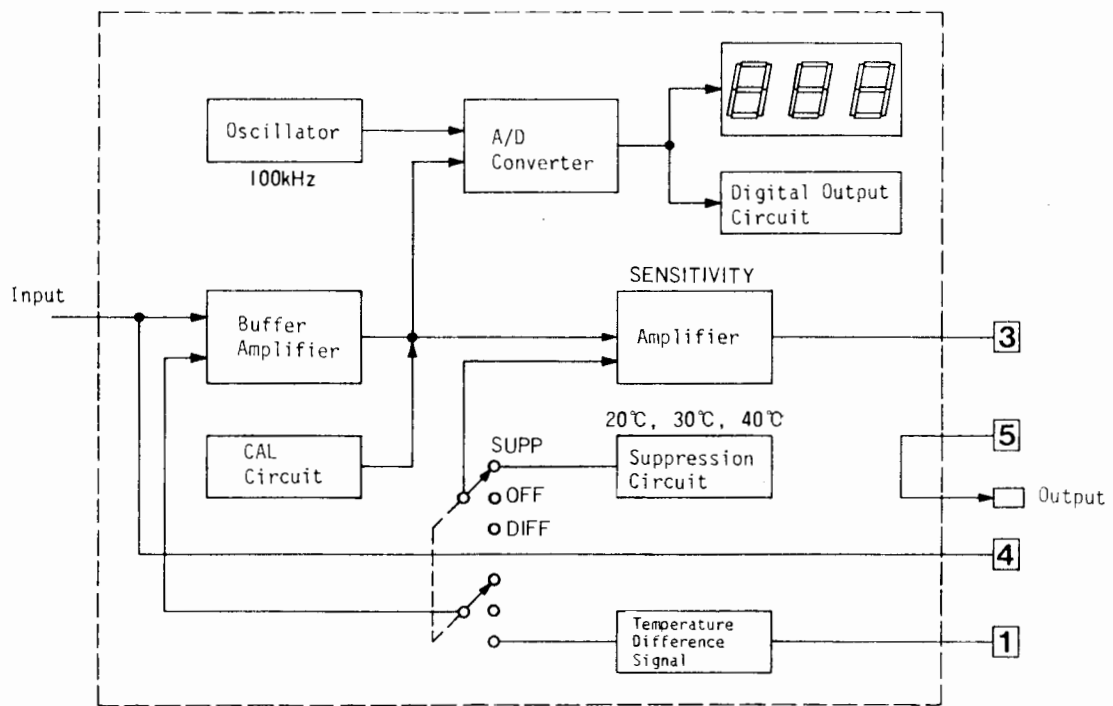

Controls and Switches

Refer to figure in page 15.

(1) Coupler
Accommodation

Accommodates the temperature coupler AW-650H.
A coupler other than the AW-650H cannot be plugged into this accommodation.
When the AW-650H is accommodated in the Coupler Housing (JH-620H, or JH-640H), place an auxiliary panel (EK-650H) here.

(2) °C
Temperature
Display

Indicates the temperature in digital figures.
Indicates the decimal point.
Flashes to indicate a negative temperature when using suppression facility or measuring a temperature difference.

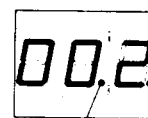

decimal point

Flickers
when temperature
is negative.

(3) SENSITIVITY
°C/DIV

Selects analog output sensitivity.
The sensitivities of 1 and 2°C/DIV are usually used for measuring temperature difference between two measuring sites and using suppression facility.

(4) SENSITIVITY
FINE

Screwdriver adjustment control. Provides continuously variable sensitivity adjustment.

(5) SUPP-OFF-DIFF

Selects measuring mode.
SUPP : Used when magnifying a small temperature change. Three temperature suppression levels of 20°C, 30°C and 40°C can be selected by an internal switch.

OFF : Used when measuring the subject's temperature directly.

DIFF : Used for measuring temperature difference between two subjects.

(6) Module Lock Lever

Used to remove the plug-in unit from the amplifier console. When selecting the internal switches, remove the module by pulling the lever; remove the side shield plate and set the switch to the desired position.

After selecting the switch, replace the shield plate to its original position and insert the module along the guide rails inside the console until it stops. Press the lever to lock the module into the console.

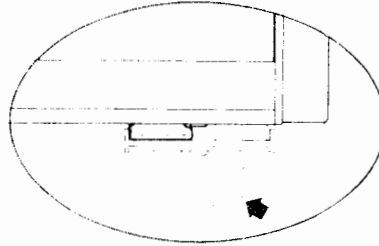

(7) 20°C/30°C/40°C
Suppression
Selector

Selects temperature suppression levels of 20°C, 30°C and 40°C. A temperature suppression level chosen by this selector is deducted from the measuring temperature. The resultant temperature is magnified, displayed on the digital display, and recorded on the associated recorder.

(8) Input Connector

A socket for the thermistor probe.

(9) Coupler Fixing
Knob

Used to fix the AW-650H Temperature Coupler to the AW-601H Temperature Module. White rings are marked around both the socket and the probe plug. This avoids an erroneous connection between the coupler and the probe. The coupler is operative only with the probe having the corresponding white ring.

Measurement

(TEMPERATURE)

SYSTEM COMPOSITION

1. Check to see that the probe, coupler, and temperature module are arranged as shown in the COMPOSITION.
2. Plug the coupler into the Coupler Accomodation(1) or into the Coupler Housing, and fix the coupler with the coupler fixing knob(9).

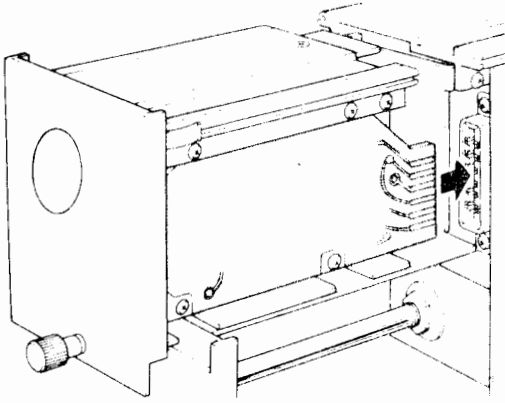

Cover AW-601H with a blank panel EK-650H when the coupler is installed in the coupler housing.

CONNECTION BOARD WIRING

Pull out the Connection Board from the Console. Connect pin terminals 3 and 5 of the channel where the AW-601H is plugged-in. After connecting the pin terminals, return the Connection Board to its original position. Refer to the operator's manual of the RMP-6004/6008/6018, Polygraph Amplifier Console or Mini-Polygraph.

AW-601H

PRECAUTIONS

AW-601H is an exclusive amplifier for Temperature coupler AW-650H. Do not plug an other coupler into AW-601H.

Do not connect two AW-650H Temperature Couplers to a single AW-601H Temperature/Module via two different signal routes --- one from the Coupler Housing; one from the Temperature Couple installed in the Temperature Module.

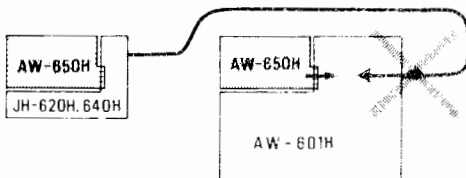

POWER ON

After making sure that the ground lead and power cord are properly connected, push the power switch of the rack, Polygraph Amplifier Console, monitor oscilloscope and recorder to turn the power on. Check to see that the power indication lamp lights.

Prepare a thermistor probe suitable for subject and site. Connect the thermistor probe to the Input Connector(8).

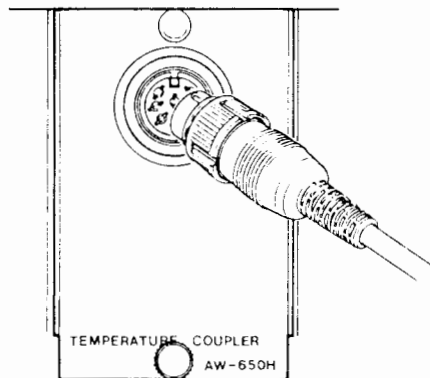

The pin assignments of the input connector are as follows.

Pin No.	Signals
1	: P _L Parallel resistor for low temperature range
2	: S _L Series resistor for low temperature range
3	: Not used
4	: Not used
5	: P _H Parallel resistor for high temperature range
6	: S _H Series resistor for high temperature range
7	: 0 volt
8	: Shield

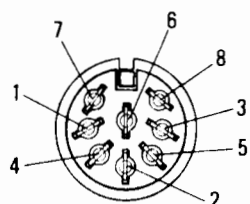

Connector Type : MAB-8100s
female type
8-pin socket
Code number : 5490718

THERMISTOR PROBE PLACEMENT

* Probe for body surface temperature measurement

Usually the body surface temperature is measured with the thermistor probe fixed by surgical tape under the axilla.

Care must be paid when measuring the surface temperature of body site other than the axilla because the thermistor will be affected by ambient temperature and the measured temperature will be slightly lower than that obtained under the axilla. In such a case cover the thermistor probe with absorbent cotton and fix with surgical tape.

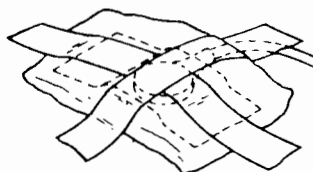

* Probe for rectal temperature measurement

When measuring human rectal temperature, determine the length of the probe to be inserted into the rectum by shifting the rubber ball, depending on how far the probe is to be inserted.

When measuring the rectal temperature of an animal, fix the animal on a table or hold the animal with hands and arms and measure the temperature as quickly as possible.

Preheat the probe before measurement. If the probe is wet with water or if glycerine is applied to the probe, insertion will be greatly facilitated.

* Probe for in-VIVO temperature measurement

Many kinds of pickups, such as for the oral cavity, esophagus, and stomach are available. Select the pickup of the desired length and diameter according to the measurement purpose. Refer to OPTIONAL ACCESSORIES at the back of this manual for probe selection.

CALIBRATION

1. Set the SENSITIVITY control(3) and SUPP-OFF-DIFF switch(5) to OFF.
2. Place the SENSITIVITY control(3) in the 10°C/DIV position.
3. Press the CAL switch on the Polygraph Amplifier Console or the Mini-Polygraph. A calibration signal which corresponds to a temperature of 40°C will be applied.
4. Observe the Temperature Display; it should read 40.0. Be certain that pen amplitude is exactly 40mm. If not, adjust the SENSITIVITY FINE control(4) for exactly 40mm in pen amplitude.

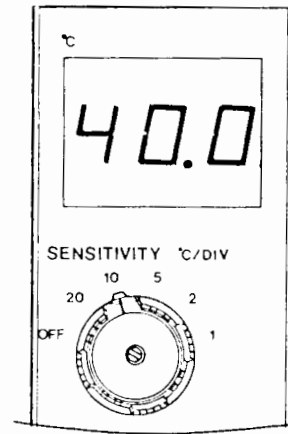

INTERNAL SWITCH SETTING

The suppression facility is used when it is desired to magnify and record the temperature of a narrow range. Three suppression temperatures are available: 20°C, 30°C and 40°C. Follow the procedures below to use the suppression facility.

1. Pull the Module Lock Lever(6) toward you and draw out the AW-601H from the Polygraph amplifier Console (or the Mini-Polygraph). Remove the side shield plate and set the Suppression Selector(7) to the desired suppression temperature (20°C, 30°C, or 40°C).

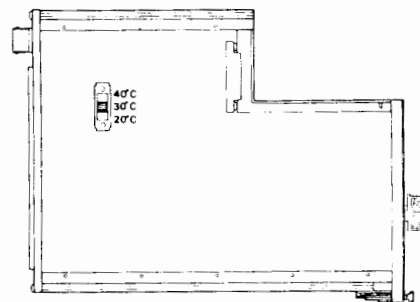

2. Replace the shield plate to its original position and plug the AW-601H into the console by reversing procedure 1.
3. Check to see that the temperature pickup is applied to the subject and the temperature which is close to the suppression temperature is displayed on the Temperature Display(2) in digital figures with a decimal point.

- Set the SUPP-OFF-DIFF switch(5) to SUPP. Temperature will be measured in the suppression mode. The temperature displayed digitally on the Temperature Display(2) is not affected by selecting the suppression mode.

Example of recording

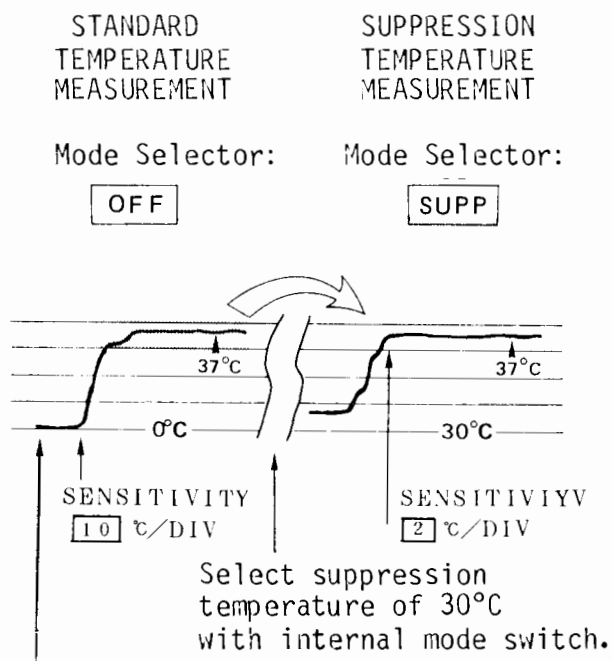

Control pen position with sensitivity selector in OFF position.

NOTE

When changing the SENSITIVITY control(3) in the suppression mode, the recorded amplitude with a calibrated sensitivity (1, 2, 5, 10, or 20°C/DIV) can be directly read on the recording paper.

MEASUREMENT

- Apply a thermistor probe to the subject and connect the probe to the input connector of the AW-650H. The system start temperature measurement.
- Adjust the SENSITIVITY control(3) for proper pen amplitude. Then start the recorder.

NOTE

Since the thermistor type temperature probe has thermal capacity (time constant), it takes some time for the probe to come up with a real temperature. Preheating the probe provides a quick temperature measurement in animal applications.

When measuring the temperature of an animal, keep the animal quiet. If the animal grows restive, temperature will rise.

When measuring the rectal temperature of animal, wet the thermistor probe with water or put glycerine on the probe to facilitate insertion.

Measurement

(TEMPERATURE DIFFERENCE)

SYSTEM COMPOSITION

When measuring the temperature difference, it is necessary to measure both the reference temperature and the temperature difference at the same time. Therefore, two sets of the temperature probe, coupler and temperature amplifier are needed. The following example shows how to measure the temperature difference between the rectal and the axilla.

CONNECTION BOARD WIRING

Pull out the Signal Connection Board from the Console and connect pin terminals.

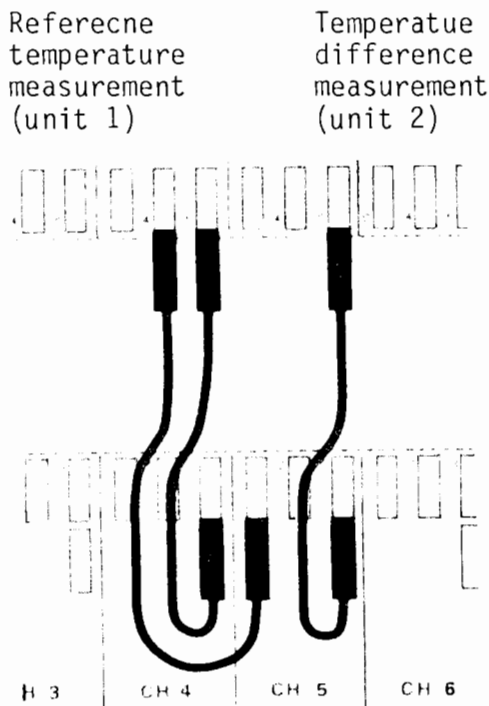

(4)-(1) : Connection for measuring temperature difference.

THERMINSTOR PICKUP

Prepare an axilla and rectum pickups. Refer to page 7 for thermistor probe placement and to page 13, OPTIONAL ACCESSORIES for variety and specification.

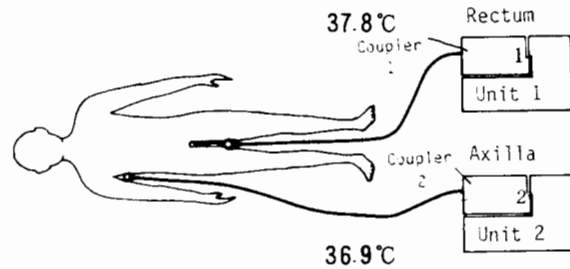

CALIBRATION

Same way as in Temperature measurement.

MEASUREMENT

After connecting the pin terminals, insert the Connection Board into its original position. The system is ready to measure the temperature difference. Operating procedures of the temperature unit are described below.

1. Set the SUPP-DFF-DIFF switch(5) of the Temperature module-2, to DIFF to measure the temperature difference.
2. Set the SENSITIVITY selector (3) of the Temperature module-1 and the Temperature module-2 to obtain the proper amplitudes respectively.

- The rectal temperature will be displayed in Module-1 and the temperature difference between the rectal and the axilla will be displayed in Module-2 in digital figures.

If the temperature difference is minus (-), the right decimal point of the temperature display will flash.

- The temperature will be recorded on the chart as shown in the following figure.

Unit 1
Rectal temperature

Unit 2
Temperature difference

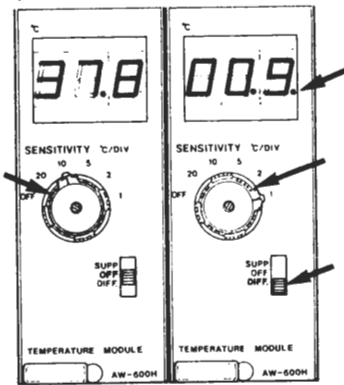

Flickers when temperature difference is negative.

Sets in the DIFF. mode

Sterilization

The thermistor probe should usually be fluid-sterilized. A detergent solution may be used as a sterilization fluid. When soaking the thermistor probe in a detergent solution, be careful not to submerge the probe connector. If the connector comes into contact with the solution, first rinse the connector thoroughly with running water and then wipe it with a dry cotton pad.

For probe cable cleaning, wipe with a gauze pad moistened with solution. Do not soak the probe cable in solution. Soaking the cable in a solution which contains alcohol for a long period of time may harden the cable.

NEVER PUT THE THERMISTOR PROBE IN A STEAM AUTOCLAVE BECAUSE MOISTURE WILL DAMAGE THE PROBE.

Alphanumeric Annotation

The AW-601H provides the following alphanumeric data to be printed on the recorder with annotation printing facility.

Data to be printed
Sensitivity: 1-2-5-10-20
Unit : °C

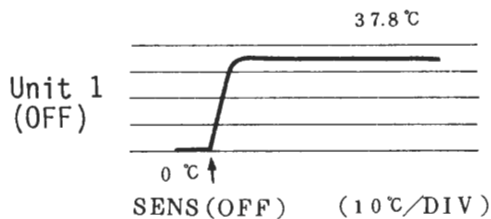

Temperature difference = Axilla temperature - Rectal temperature
= 36.9 - 37.8

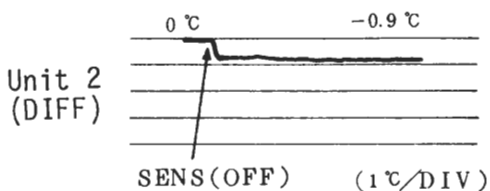

Specifications

TEMPERATURE MODULE (AW-601H)

Input impedance	<200K Ω , $\pm 2\%$
" (In DIFF mode)	<100K Ω , $\pm 2\%$
Measuring range	0°C - 50°C (see figure below)
Temperature indication	Digital, 3 digits.
Indication period	Approx. 3 sec.
Sensitivity	1, 2, 5, 10, 20°C/DIV and OFF.
Suppression temperature	20, 30, and 40°C
Accuracy	< $\pm 0.3^\circ\text{C}$ (In the temperature range from 5°C to 42°C)
Maximum output voltage	>5 volts
Calibration signal	40°C (A calibration signal is applied when the CAL switch on the Polygraph Amplifier Console is pressed.)
Temperature difference measurement	Made by SUPP-OFF-DIFF switch selection.
Coupler power source	± 15 volts, $\pm 6\%$, 100mA
Dimensions	W50 x H200 x D280 (mm)
Net weight	Approx. 0.7kg

TEMPERATURE COUPLER (AW-650H)

Input method	A bridge circuit
Gain	32dB (40 times)
Output sensitivity	100mv/ $^\circ\text{C}$
Accuracy	0.2°C (when combined with the temperature pickup.)
Temperature range selection	Automatic selection of L and H.
Supply voltage	3 volts.

Dimensions W50 x H75 x D125 (mm)

Net weight Approx. 0.2kg.

Temperature range

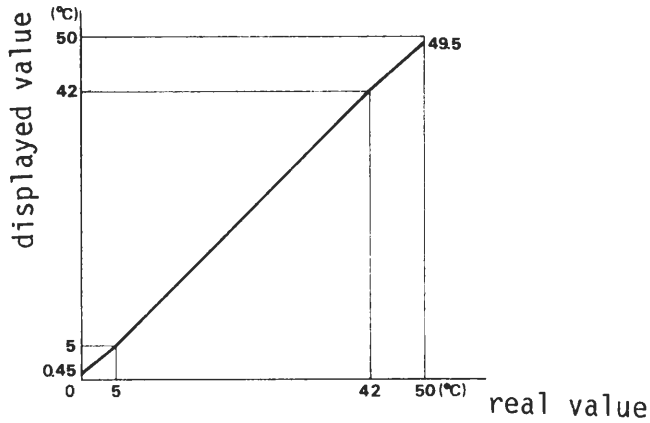

Optional Accessories

THERMISTOR PROBES

Thermistor probe selection guide is listed in Table-1.

1. For skin surface and in-vivo temperature measurements.

Placed in the axilla armpit or attached to another skin with surgical tape. The probes equipped with long probe tip are inserted in to measure the temperature of esophagus, stomach, etc.

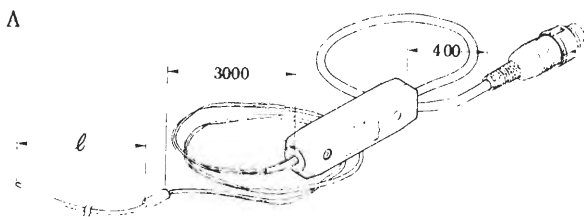

Figure A Flexible polyethylene tubing type

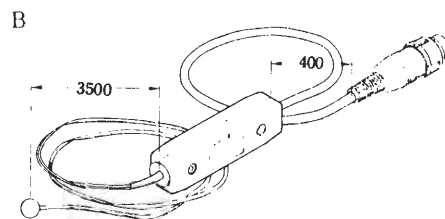

Figure B Disc type

C

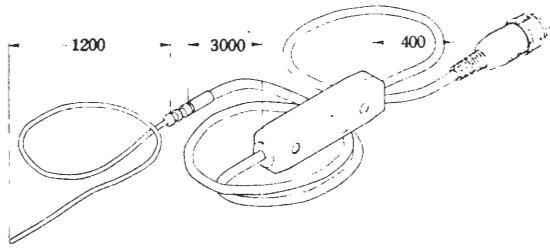

Figure C Catheter-tip type

D

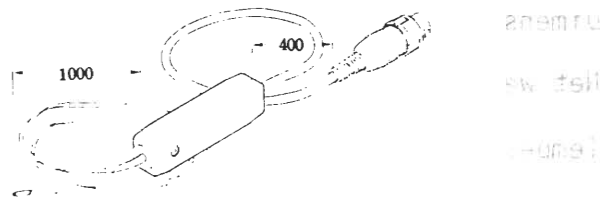

Figure D Flexible Polyethylene tubing type

2. For general purpose

Clinical thermometer type with a quick temperature response. Placed in the axilla or oral cavity.

E

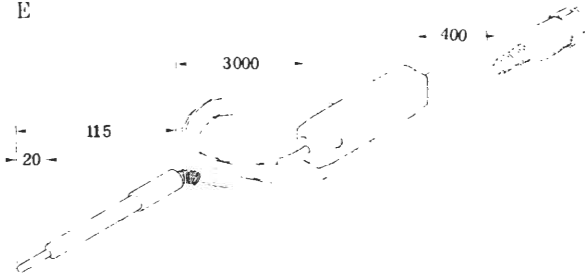

Figure E Glass rod type

3. For rectal temperature measurement

F

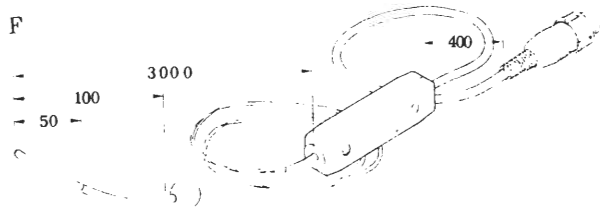

Figure F Catheter-tip type

G

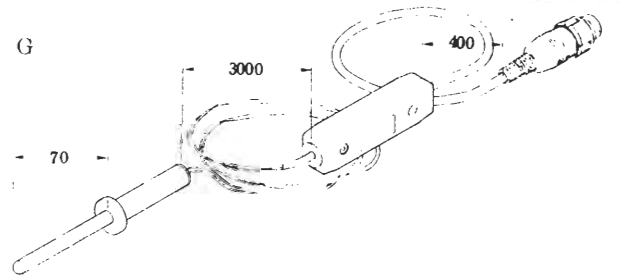

Figure G Bakelite stick type

4. Injection needle type

H

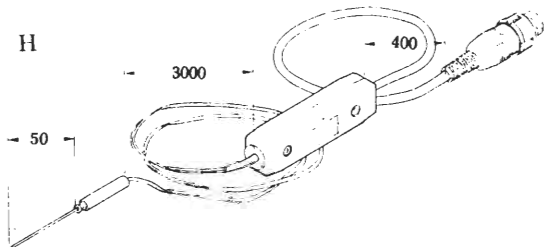

Figure H Injection needle type

Table-1 List of thermistor probe

Figure	Probe type	Code No.	Length (mm)	Diameter (mm)	Time constant in water (mm)	Time constant in air (mm)	Major application
A	THR-PT-S001	4730382	600	2	5	25	Human
	THR-PT-S002	4730391	35	2	5	25	Animal
	THR-PT-S003	4730408	50	2	0.5	25	Animal
	THR-PT-S005	4730417	300	1	0.5	10	Human
	THR-PT-S006	4730426	600	1	5	10	Human
	P-S001	4730533	1000	3	5	25	General purpose
	THR-PT	4730435	30	2	5	25	Animal
	THR-T	4730444	30	2	5	25	Animal
	THR-P	4730453	585	2	5	25	Human
B	THR-D	4730506	-	10	2	10	Human, skin surface, stick-on type
C	PV-S001	4730524	1200	2.3	0.4	5	General purpose catheter-tip type
D	PT-S007	4730542	-	2	0.5 to 1	20 to 50	General purpose
E	THR-3T	4730471	20	4	0.35	1.75	Animal, general purpose
F	THR-PV	4730462	100	4	9	45	Human, rectum
G	THR-I	4730489	70	7	3	15	Human
H	THR-NST	4730498	50	1	1	5	Human, injection needleless type

Panel Illustration

TEMPERATURE COUPLER
AW-650H

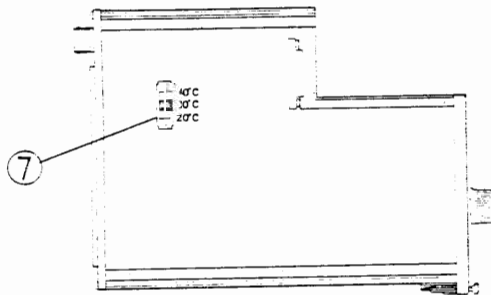
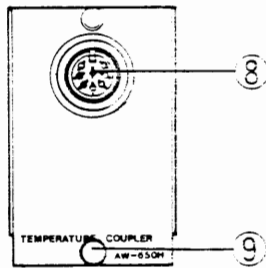

TEMPERATURE MODULE
AW-601H

